

PROTECT

by LeakSmart®

Shut-off Valve System
User Manual



Table of Contents

Installation Overview:

System Components.....	4
Setup Requirements.....	6
Important Installation Information.....	7

Section I:

LeakSmart Hub 3.0 Pre-Installation Customer Setup Requirements.....	8
---	---

Section II:

LeakSmart Hub 3.0 Installation.....	10
Performing a Factory Reset.....	13
Connect the Hub to the Home Wi-Fi Network.....	15
Protect by LeakSmart Setup.....	16
Pair the Protect by LeakSmart to the Hub 3.0.....	18
Test Local and Remote Control of the Valve Control Head.....	20

Table of Contents

Section III:

Protect by LeakSmart Shut-Off Valve Installation	22
Installation.....	24

Section IV:

LeakSmart Sensor Setup and Operation.....	30
Place and Test Sensors.....	34
Alert Setup.....	38
Adding Alert Contacts.....	38
Test Leak Simulation.....	39
Clearing Test Leaks.....	39

Encuentra nuestro manual en español en LeakSmart.com/support/manuals/

Register your system at LeakSmart.com/support/registration/

Troubleshooting: LeakSmartPro.com/support/troubleshooting/

LeakSmart is compatible with other smart home products. Check out LeakSmart.com/integrations

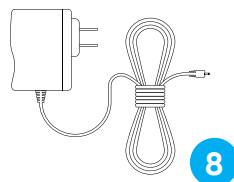
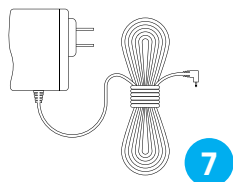
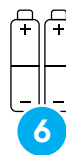
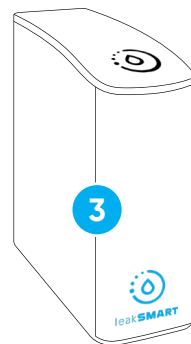
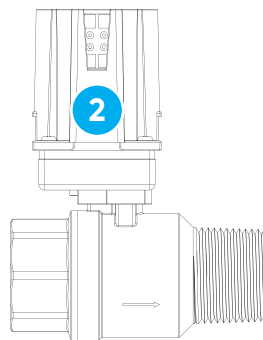

System Components:

- 1 Valve Control Head
- 2 Shut-off Valve
- 3 Hub 3.0* with pre-installed Rechargeable Lithium Battery
- 4 Sensors (3)*
- 5 AA Batteries (4)
- 6 AAA Batteries (9)*
- 7 Valve Control Head AC Power Adapter (18' reach)
- 8 Hub AC Power Adapter (6' reach)*
- 9 Setup Manual

* Hub 3.0 and Sensors may be sold separately.



Note: Additional fittings may be required based on installation requirements.

Encuentra nuestro manual en español en LeakSmart.com/support/manuals/

Setup Requirements



Professional installation recommended.

5-year LeakSmart warranty when purchased and installed by a professional. All other purchases and installations include a 2-year warranty.

To set up the LeakSmart System, you need:



• Wi-Fi



• An iOS or Android phone or tablet



• A free LeakSmart account



Note: LeakSmart devices in the home communicate on a local zigbee RF network and do not require Wi-Fi to protect your home. **Wi-Fi is required for initial set up and notifications.**

Important Installation Information



CAUTION:

- Do not install on fire suppression systems/fire sprinkler water lines.
- Never place your fingers inside the Shut-off Valve.
- Do not grip the plastic motor drive for leverage when installing the valve.
- LeakSmart recommends compliance with all local building and safety codes when installing the Protect by LeakSmart System.
- LeakSmart Hub and Sensors are for indoor use only.
- For outdoor use of the valve, utilize the approved enclosure box available from LeakSmart.

LeakSmart Hub 3.0 Pre-Installation Customer Setup Requirements

Before installing the LeakSmart Hub 3.0, the customer needs an active LeakSmart account to register the hub.



The homeowner's Wi-Fi network and password are used to activate the hub. It's best practice to get that information before starting the installation process.

- 1 Download the LeakSmart app from the Apple App Store or Google Play on your smart phone or tablet.



- 2 Open the app and tap **create an account**.
- 3 Follow the instructions in the app to create your account.
- 4 Create a password that:
 - Is between 8-19 characters
 - Has at least one number or special character
 - Has at least one capital letter and one lower case letter

LeakSmart Hub 3.0 Pre-Installation Customer Setup Requirements

- 5 Tap **Next**.
- 6 Review your information and agree to the terms of use.
- 7 Tap **Submit** to create your account.

After you create the account, activate and verify the account.

Activate Account

- 1 Go to your email.
- 2 Open the email from **noreply@mywateralerts.com**.
- 3 Tap the **activate your account** link in the email.
- 4 Look for the on-screen confirmation.
- 5 Log in to your account in the LeakSmart app.



Note: Your email will be your LeakSmart account name.

LeakSmart Hub 3.0 Installation

- 1 Place the hub in a location central to the other LeakSmart devices.
- 2 Plug the hub 3.0 in, using the AC power adapter cord (6' reach).
 - The hub 3.0 contains a rechargeable lithium battery, intended to be a backup in the event of a power outage.
 - The hub 3.0 cannot be registered/activated on battery power; it must be plugged in.

Central location:

place hub in a location central to other devices.

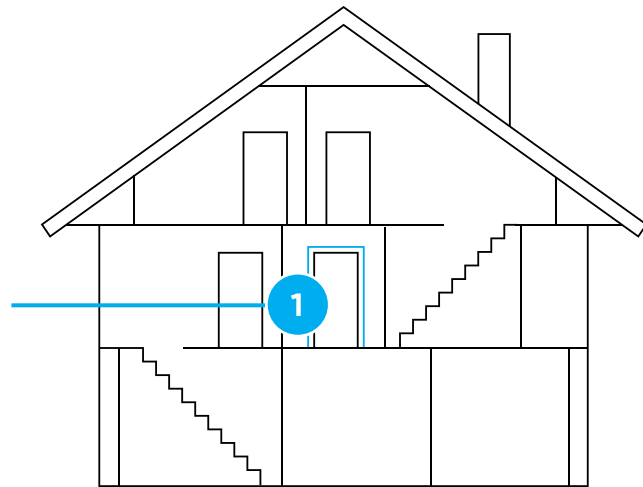

LeakSmart Hub 3.0 Installation

- 3 Slide the on/off button on the back of hub to the **ON** position.
 - 3a A solid red light on top of the hub indicates that it's on.

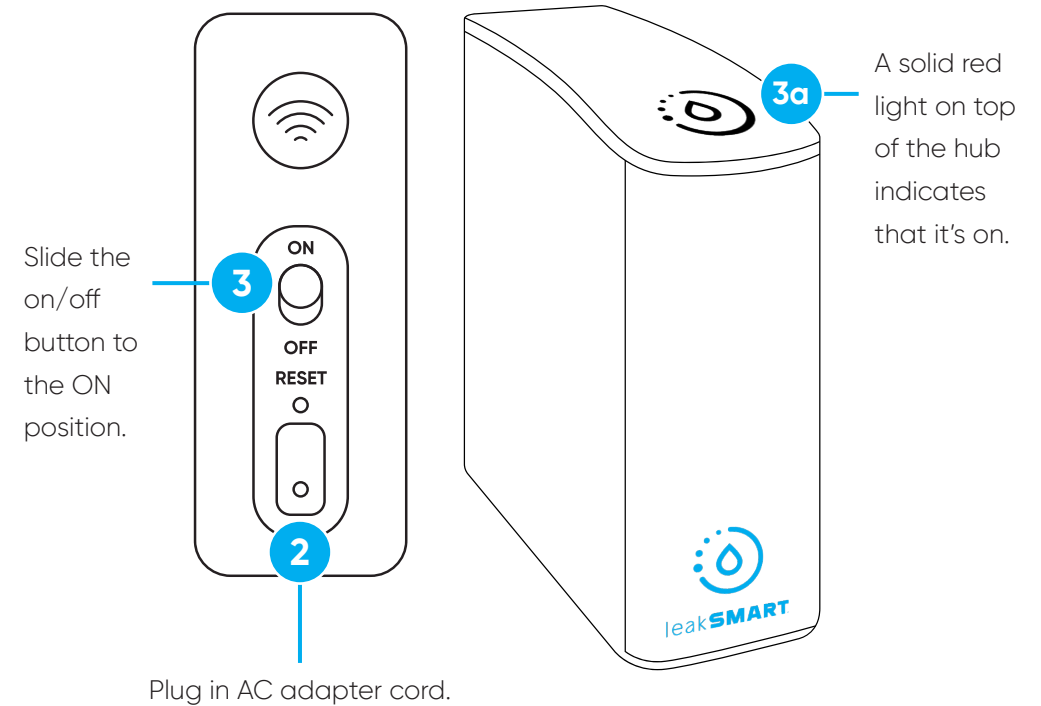

LeakSmart Hub 3.0 Installation

- 4 Log into the LeakSmart app with homeowner/customer account credentials.
- 5 Tap **Add Hub**.
- 6 Back out of - but do not close - the LeakSmart app.
- 7 Open the phone or tablet settings.
- 8 Open Wi-Fi settings.
 - The LeakSmart Hub should appear in your list of available networks as LeakSmart-XXXX.
 - The four-digit code is the last four digits of the MAC address of LeakSmart Hub. (You can find this number on the battery door of the Hub).
- 9 Confirm that you have successfully connected your phone or tablet to the LeakSmart-XXXX network.
- 10 Return to the LeakSmart app.

Performing a Factory Reset (If Needed)

- 1 Use a pin (or something with a thin tip) to press and hold the factory reset button on the back of the LeakSmart hub for fifteen-seconds.
 - 1a A purple light on top of the hub indicates that the hub is ready for factory reset.
- 2 Turn the hub off, then back on.
- 3 The LeakSmart hub will then show up on the Wi-Fi network.
- 4 Tap **LeakSmart-XXXX** to join the network.

Turn the hub off/on.

Press and hold the reset button to perform a **factory reset**.

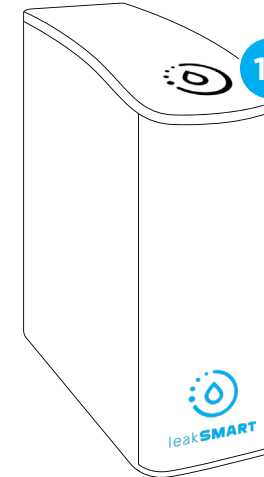
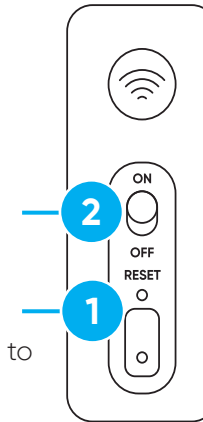

A purple light on top of the hub indicates that the factory reset is complete.



Note: If the LeakSmart Hub network does not appear, perform a factory reset.

LeakSmart Hub 3.0 Installation

- 11 Tap the name of the **homeowner's Wi-Fi network**.
(network must be 2.4GHz in order to work).
- 12 Type the homeowner's Wi-Fi password in the password field.
- 13 Tap **Connect**.
- 14 A solid blue light on top of the hub indicates that the hub is connected to the home Wi-Fi network.



Note: After connecting to Wi-Fi, the hub will register itself on the cloud and should appear in the app.

Connect the LeakSmart Hub 3.0 to the Home Wi-Fi Network

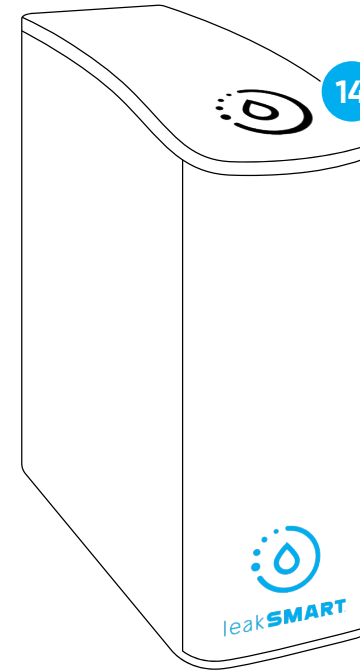

The hub's LED indicator will turn blue when successfully connected to the home Wi-Fi network.

Protect by LeakSmart Setup



Keep the LeakSmart valve control head connected to the shut-off valve and place it at the installation location, so you can verify that it is within communication range to the hub.

Power the unit:

- 1 Open the LeakSmart app and tap **Add Devices**.
- 2 For the valve control head, use a Phillips head screwdriver to open the battery compartment and install four AA batteries.
- 3 Connect the jack of the 9V Supply Cord (18' reach) to the bottom of the valve control head. Then, plug the 9V Supply Cord into an outlet.



CAUTION:

- Do not replace the four AA batteries with a 9V battery; this will void the warranty.
- If the provided AC power cord isn't long enough to reach the outlet, be sure to replace it with a low voltage extension cord. We recommend the LeakSmart low voltage extension cord.

Protect by LeakSmart Setup

Battery compartment: open with a Phillips head screwdriver and install (4) AA batteries.

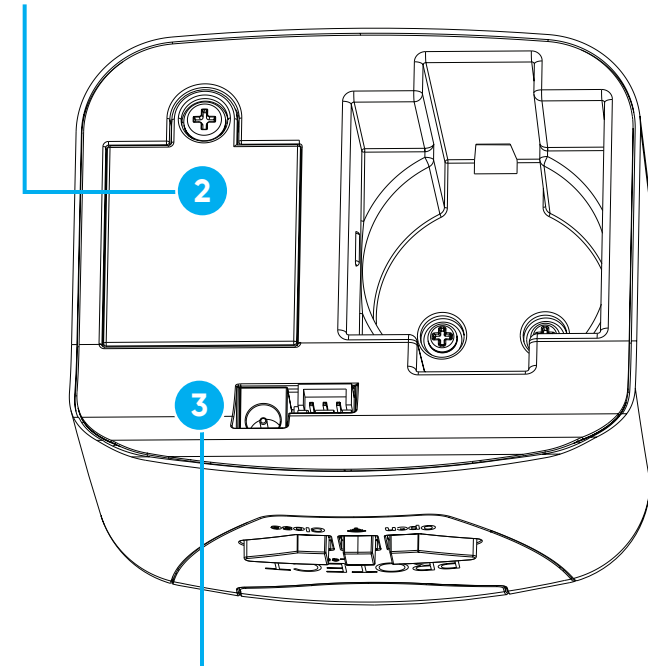

18' 9V Supply Cord Jack: plug cord into outlet after insertion.

Pair the Protect by LeakSmart to the Hub 3.0

- 1 Tap **Next** in the LeakSmart app to initialize a three-minute pairing mode.
 - A flashing green light on top of the hub indicates that it's in pairing mode.
 - A solid green light indicates that the hub is updating software. The light will turn blue when the update is complete.
 - A solid blue light on top of the hub indicates that the three-minute pairing mode has ended.
- 2 A flashing blue light on the valve control head indicates that it's ready to be paired.
- 3 Tap **Next** in the LeakSmart app.
- 4 Press and release the center button on the valve control head to pair it to the hub.
- 5 When the valve control head rapidly flashes blue, or all the lights turn off, you've successfully paired it to the hub.
 - Verify that the valve appears in the app before moving on.



Note: The valve may take up to one minute to pair. If valve does not pair, rapidly press the center button 5 times to reset. A blue light will flash, indicating the valve is ready to be paired.

Pair the Protect by LeakSmart to the Hub 3.0

Flashing green light: pairing mode is active.

Solid green light: hub software update is in progress. Light will turn solid blue when update is complete.

Solid blue light: pairing mode has ended.

Double blue light: pairing mode is active.

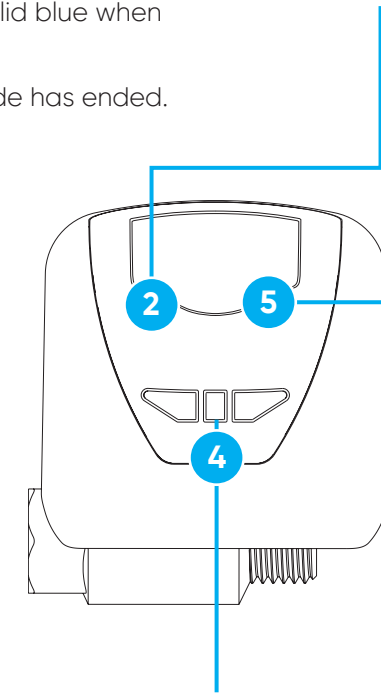
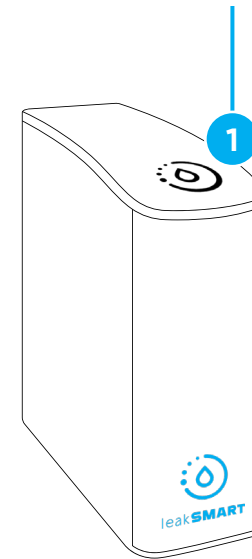

Rapid blue light/no lights: successfully paired.

Center button: press and release to pair to the hub.

Test Local and Remote Control of the Valve Control Head



Manually test that Protect by LeakSmart can communicate with the hub from the intended install location.

Test local control using the valve control head.

- 1 Press the **Open** button on the front of the valve control head.
 - 1a A steady green light on the front of the valve control head indicates the valve is open.
- 2 Press the **Close** button on the front of the valve control head.
 - 2a A steady red light on the front of the valve control head indicates the valve is closed.

Test remote control using the LeakSmart app.
On the home screen:

- 3 Tap the **Open** button.
- 4 Then tap the **Close** button.

Test Local and Remote Control of the Valve Control Head

Green light: indicates valve opening.

Red light: indicates valve closing.

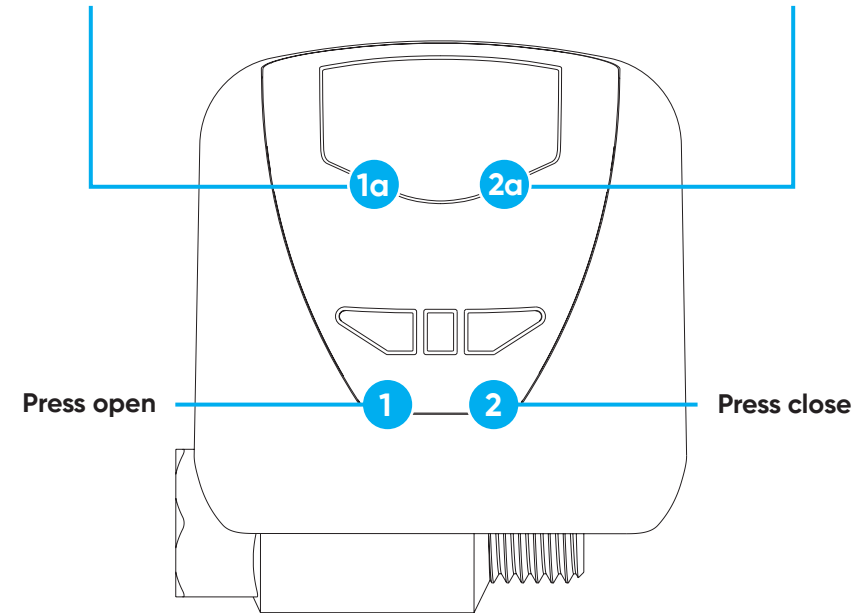

Protect by LeakSmart Shut-Off Valve Installation



Before starting the installation process, be sure that you have all the necessary components, fittings, and other equipment required for installation.

Shut-off Valve Installaion

- 1 Remove the valve control head from the shut-off valve. Set the valve control head aside to avoid potential damage.
- 2 Attach the appropriate adapters needed to install the valve on your pipe configuration. Adapters not included.

Protect by LeakSmart Shut-Off Valve Installation

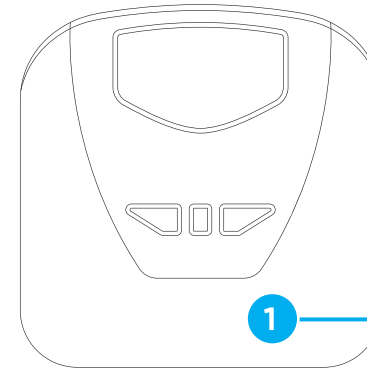

Valve control head:
remove from the shut-off
valve and set aside.

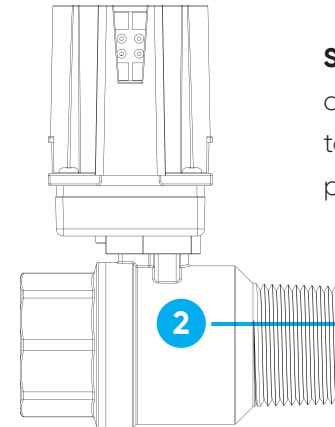

Shut-off valve:
attach appropriate adapters
to install the valve onto the
pipe. (Adapters not included.)

Installation

- 1 Turn off the main water supply.
- 2 Locate the lowest fixture and drain the main water line (turn on the hot and cold water until no more water comes out).
- 3 Install the shut-off valve assembly.

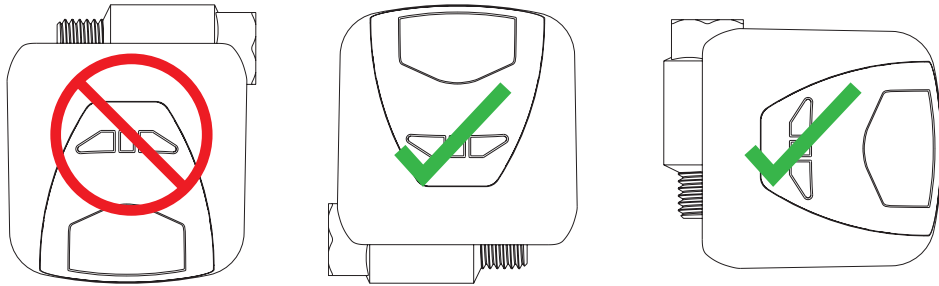

CAUTION:

- Install the valve so that the controller will rest vertically or horizontally, **NOT upside down**.
- Do not solder fittings near the water meter or the Protect by LeakSmart valve control head to prevent heat from affecting the devices.

Installation

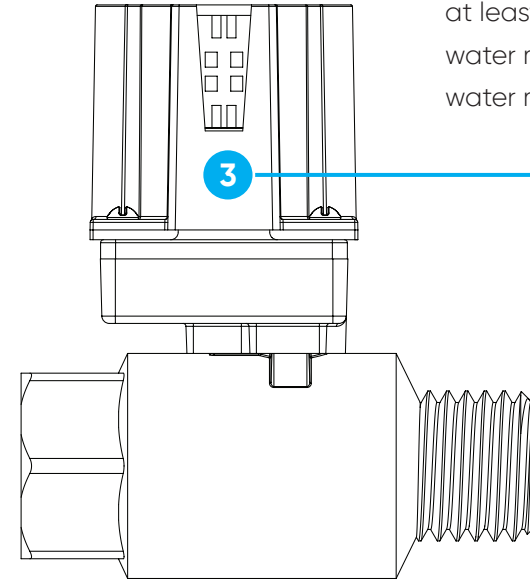

Shut-off valve assembly: install at least 8" downstream of the water main manual shut-off and water meter.

Installation

- 4 Once you've installed the assembly, turn on the main water valve.
- 5 With the front of the valve control head facing you, reattach the valve control head to the shut-off valve by sliding it over the motor housing until it clicks into place.
 - Ensure that the valve control head is firmly engaged on the shut-off valve.

Installation

Valve control head: reattach to the shut-off valve by sliding on until it clicks into place.

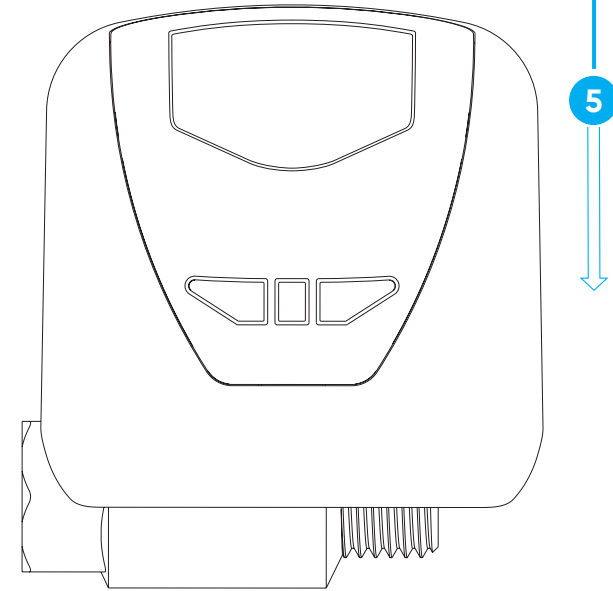

Installation

- 6 Press the **Open** button on the front of the valve control head to check the functionality.
 - 6a A flashing green light indicates that the valve is opening.
 - 6b A steady green light indicates that the valve is open and water will run through the valve.
- 7 Turn off the lowest hot and cold fixture and check for leaks.

CAUTION:

- Be aware of the water hammer effect when first opening the valve. There may be air remaining in the plumbing lines from cutting in the valve. Once the air is released, your system will go back to normal pressure.

Installation

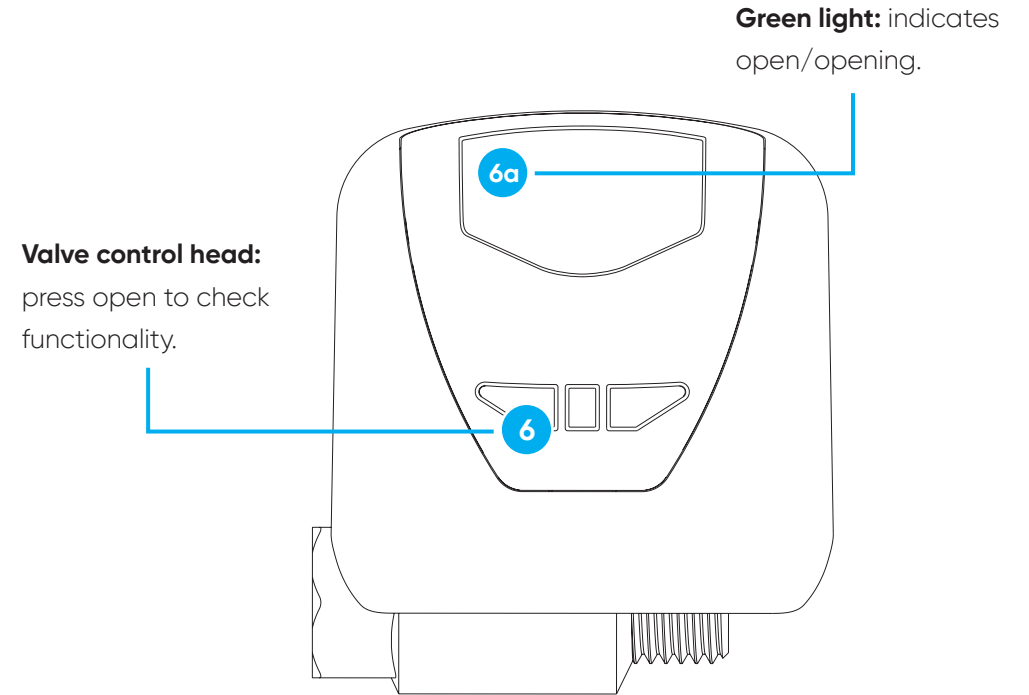

LeakSmart Sensor Setup and Operation



Note: To complete the setup, you will need a **Phillips head screwdriver**, a **damp cloth** and a **dry cloth**.

- 1 Use the Phillips head screwdriver to remove the battery compartment door from the LeakSmart Sensor.
- 2 Install the three provided AAA batteries, but **DO NOT REPLACE THE BATTERY DOOR**.
 - A chirp from the sensor indicates that the batteries have been installed.
 - A flashing blue light from the sensor indicates that it's ready to pair.
- 3 Open the LeakSmart app on your phone or tablet.
- 4 Tap **Add Devices** from the home screen.
- 5 Tap **Next** in the LeakSmart app until you see the pairing mode screen showing device count.

LeakSmart Sensor Setup and Operation

Battery compartment: temporarily remove door using Phillips head screwdriver.

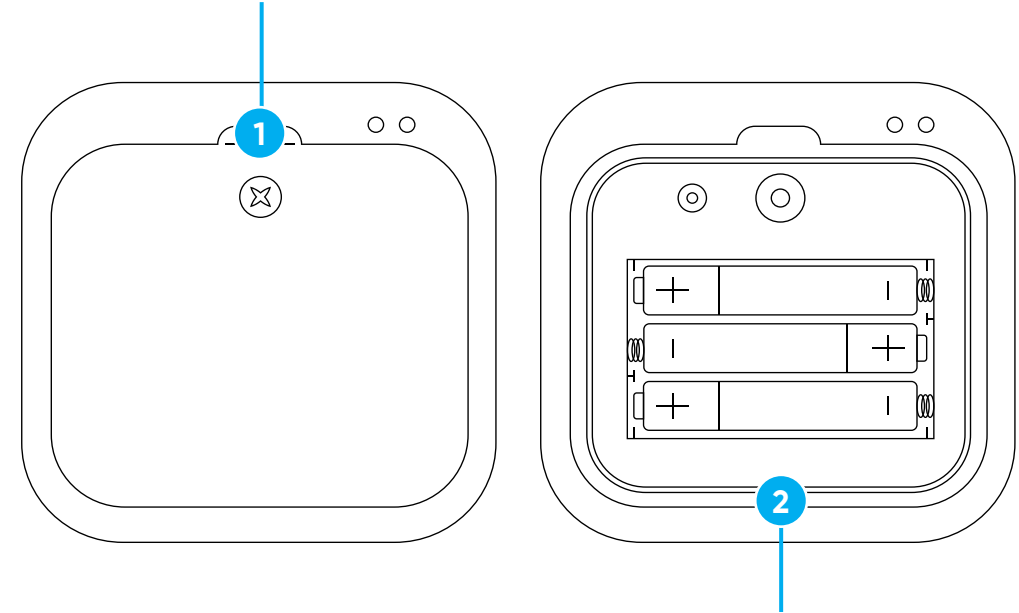

AAA batteries: install three batteries after temporarily removing battery door.

LeakSmart Sensor Setup and Operation

- 6 To pair the sensor to the hub, press the black button inside the battery compartment of the LeakSmart Sensor **one time**.
- 6a When the pairing is successful, the light on top of the sensor will blink slowly five times, and you'll hear three quick beeps.
- 7 In the LeakSmart app, watch for the total device count and the sensor count to each increase by one.
- 8 Tap **All My Devices are Paired**.
- 9 With the sensor successfully paired, replace the battery compartment door.
- 10 To pair additional sensors, repeat steps 1-7.

LeakSmart Sensor Setup and Operation

Black button: to pair the sensor to the hub, press this button once.

Battery compartment: replace door once sensor is successfully paired.

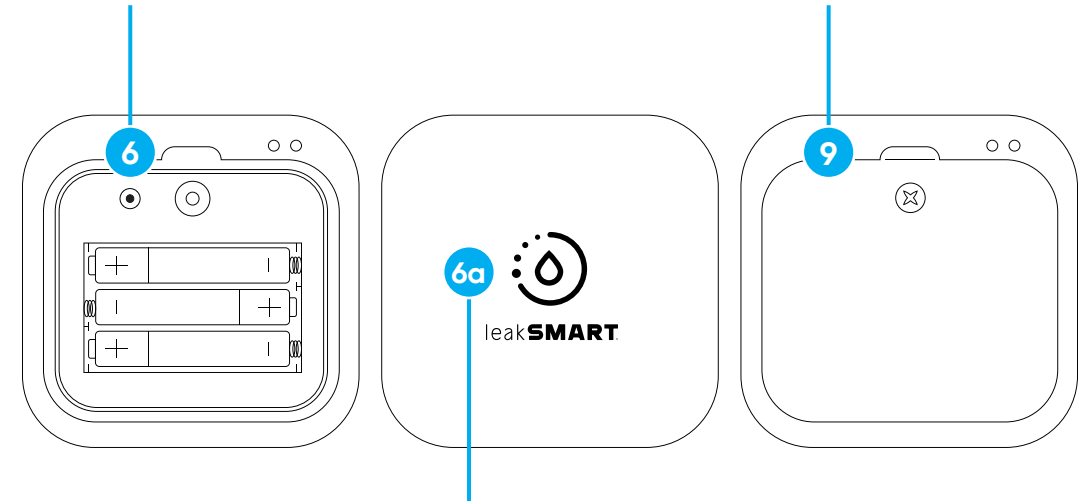

Sensor: five slow flashes from the LED light and three quick beeps indicate that the pairing is successful.



Note: Pairing mode will last for three minutes. If you don't successfully pair the sensor(s) before the three-minute pairing mode ends, you'll have to start over at step 4.

Place and Test Sensors

- 1 Newly paired sensors are displayed under **Untested Sensors** with a  indicating that the sensor needs to be named, tested, and placed in its intended location.
- 2 Tap on a sensor from the untested sensors list. The selected sensor will beep to identify itself.
- 3 When you identify the beeping sensor, tap **Ok, I have the sensor** in the app.
- 4 Take the sensor and a damp cloth to a location you need to monitor for water. We recommend placing the sensor near old pipes, toilets, washing machines, water heaters, bathtubs, crawl spaces, utility closets, or anywhere you want to monitor water leaks.
- 5 In the app, name the sensor to identify its location, e.g., masterbath toilet (the sensor name can have a maximum of 20 characters).
- 6 Tap **Add Location** to initiate test mode.

Place and Test Sensors



Tap **All My Devices are Paired** in the LeakSmart app. Look for untested sensors using .



After identifying the untested sensor, Tap **Ok, I have the sensor** in the app.

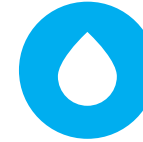

Take the sensor and a damp cloth to a location you need to monitor for water.

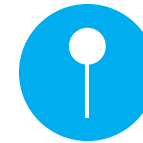

In the app, name the sensor to identify its location. Tap **Add Location** to initiate test mode.

Place and Test Sensors

- 7 Press and hold the damp cloth to the gold pins on the back of the sensor to trigger a leak (it will beep).
- 8 Keeping the damp cloth on the gold pins, tap **My Sensor is Beeping** in the app. Hold damp cloth until it displays success.
- 9 Remove the damp cloth and dry the gold pins.
- 10 Place the sensor flat on the floor in your desired location, with the LeakSmart logo facing up.
- 11 In the LeakSmart app, set the sensor to its mode.
 - 11a Tap **Protect** to have this sensor automatically shut off the water and send alerts when it detects a leak.
 - 11b Tap **Detect-Only** to have this sensor only send alerts when it detects a leak.
 - 11c Return to home screen of the app to check the signal strength of paired sensors. If only 1 blue bar or all gray bars are indicated, consider moving the hub to a more central location or purchase a LeakSmart Range Extender.
- 12 Tap **Finish**.
- 13 Follow the on-screen prompts to set up alerts (these can be set up later in the app alerts on your phone or tablet, or you could follow the next section of this manual to set up alerts).
- 14 Repeat steps 1-11 for any remaining sensors.

Place and Test Sensors

Gold pins: hold damp cloth on these to trigger a leak until "success" is displayed. Once confirmed, remove damp cloth and dry pins.

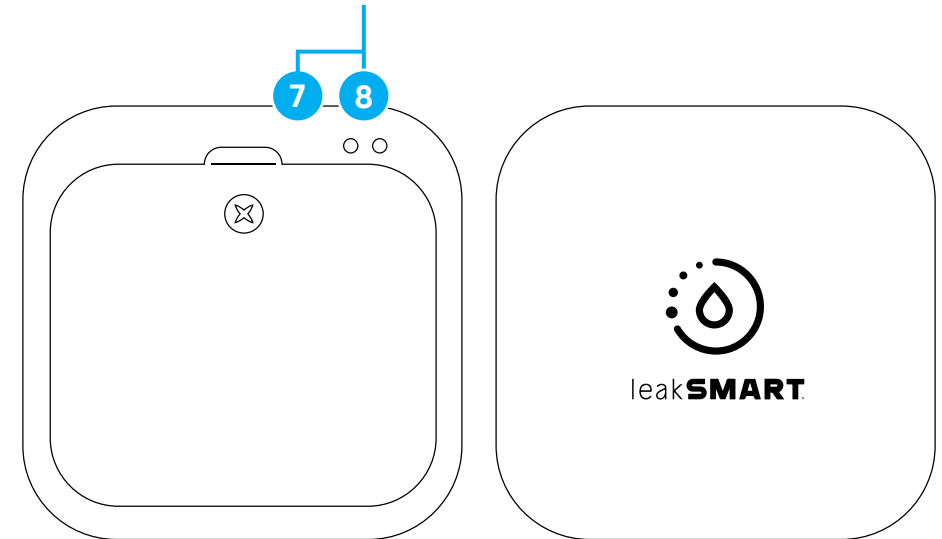

Note: If "success" does not display, refer to the website for additional troubleshooting tips.

Alert Setup

- 1 Open the LeakSmart app.
- 2 Tap **Alerts** .
- 3 Customize alerts to your preference.

Adding Alert Contacts

- 1 Tap **Add Contact** (You may add up to 20 contacts).
- 2 Type contact's name.
- 3 Toggle on **Email Alerts** and type the contact's email address.
- 4 Toggle on **Text Message** alerts and type the contact's phone number.
- 5 Tap **Done** to save added contact(s).

Test Leak Simulation

Now that the complete system is installed, simulate a leak to test the response.

- 1 Ensure your valve is in the open position.
- 2 Press and hold the damp cloth to the gold pins on the back of a sensor, so that the sensor begins to beep.
- 3 If this sensor is set to **Protect** mode, confirm that the valve closes.
- 4 Look for the banner at the top of the LeakSmart App to turn red. Confirm that your contacts receive the email and/or text alerts that a leak has been detected. If alerts are not received, tap **Alerts** in the app and check that they are turned on.

Clearing Test Leaks

- 1 Dry off the gold pins and the back of the sensor.
- 2 Place the sensor in its location.
- 3 Confirm the banner at the top of the LeakSmart App turned green. (System OK)
- 4 Open the valve.

FCC Compliances:

Hub 3.0 Compliance:

FCC ID: 2A05J-WLSHUB3, CONTAINS FCC ID: TLZ-CU300 | IC ID: 23626-WLSHUB3, CONTAINS IC ID: 6100A-CU300

Valve and Sensors Compliance:

FCC: W72-ZICM357SP1 | IC:8254A-ZICM357SP2

This equipment has been tested and found to comply with the limits for a Class B digital device, pursuant to part 15 of the FCC Rules. These limits are designed to provide reasonable protection against harmful interference in a residential installation. This equipment generates, uses and can radiate radio frequency energy, and if not installed and used in accordance with the instructions, may cause harmful interference to radio communications. However, there is no guarantee that interference will not occur in a particular installation. If this equipment does cause harmful interference to radio or television reception, which can be determined by turning the equipment off and on, the user is encouraged to try to correct the interference by one or more of the following measures:

- Reorient or relocate the receiving antenna
- Increase the separation between the equipment and the receiver
- Connect the equipment into an outlet on a circuit different from that to which the receiver is connected
- Consult the dealer or an experienced radio/TV technician for help

2" Item #8850310
1.5" Item #8850300
1.25" Item #8850200
1" Item #8850100
3/4" Item #8850000

WARNING

This product can expose you to chemicals including lead which is known to the State of California to cause cancer, birth defects and other reproductive harm. For more information, go to www.P65Warnings.ca.gov



NSF/ANSI 61

Questions? Contact our technical service team: 855-532-5457

Designed in the U.S.A. Made in China.
© 2019 LeakSmart, Inc. All rights reserved.